

Pre-Filtered GPS LNA (Low Noise Amplifier)

Designed to amplify GPS signals while protecting the GPS receiver by filtering out interferers

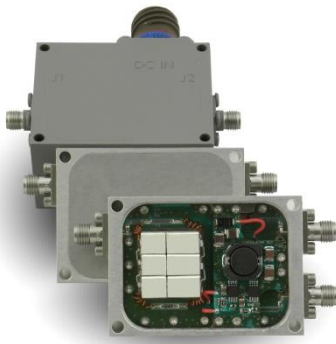

Features

- Pre-Filtered
- Low Noise Figure, 1.8 dB Typical
- Wide Input Voltage Range
- Tested to many MIL-STD-810 & MIL-STD-461 Requirements
- Small Lightweight Hermetic Package
- Contact factory for custom configurations

Applications

- Inline Booster
- Satellite Navigation
- Avionics
- Marine Navigation
- Survey/Mapping
- Military

The 312 series pre-filtered GPS LNA module is designed to amplify GPS signals while protecting the front end of the GPS receiver by filtering out interferers from an increasingly crowded EM spectrum. The module leverages API Technologies' core competencies in low-loss filter, amplifier and mechanical design that results in a module that maximizes out of band rejection while minimizing system noise figure and maintaining a small size. The pre-filtered GPS LNA is offered in a wide range of performance options including GPS band configuration, gain level, supply voltage, multiple outputs and input and output connectors.

Parameter				Specification (at +23 Deg C)						Units			
Band Select Center Frequency				L1=1575.42, L2=1227.6, L5=1176.45						MHz			
Band Select Passband Bandwidth				20.46						MHz			
Gain Select Passband Gain \pm 3dB				16	19	22	25	28	31	34	37	40	dB
Output P1dB, min				+3						dBm			
Output IP3, min				+20						dBm			
				Minimum		Typical		Maximum					
Noise Figure (at Band Select Center Frequency)						1.8		2.5				dB	
Rejection												dBc	
L1	L1/L2	L1/(L2/L5)	L1/L5										
f \leq 1410 MHz	f \leq 1050 MHz	f \leq 998 MHz	f \leq 998 MHz		-40		-45						
	f@1410 MHz	f@1410 MHz	f@1410 MHz										
f \geq 1730 MHz	f \geq 1730 MHz	f \geq 1730 MHz	f \geq 1730 MHz										
Passband Input Return Loss				-9.5		-17.7						dB	
Passband Output Return Loss				-9.5		-14.0						dB	
Passband Group Delay Variation						\pm 2.0						ns	
Supply Voltage												VDC	
Standard				+4.8				+36					
Low-Voltage				+3.0				+5					
Supply Current (Icc)												mA	
\leq 25 dB Gain Option						50		55					
\geq 28 dB Gain Option						68		75					

Typical Performance Graphs - L1/L2

Gain

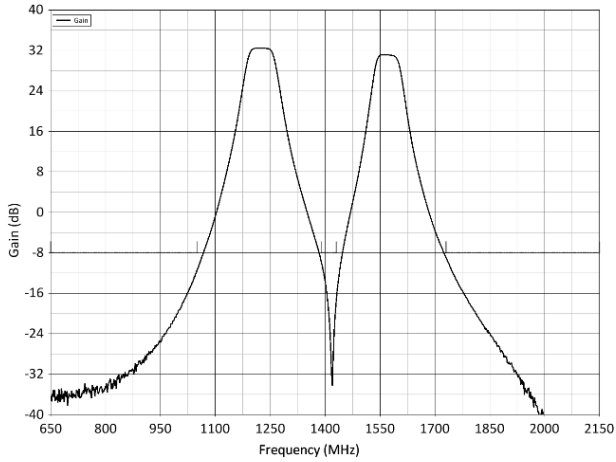

Noise Figure at +25°C

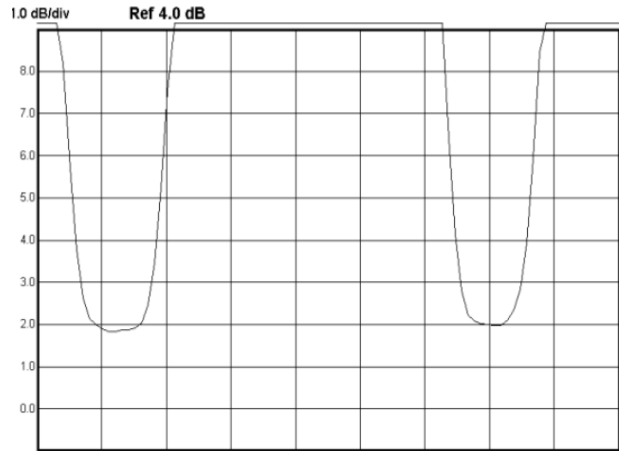

Gain Variation over Temperature

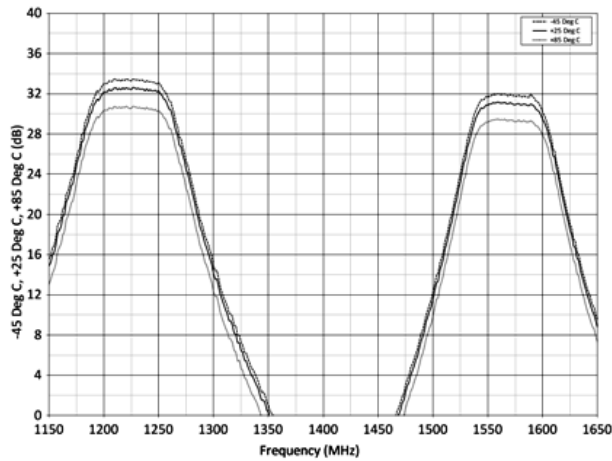

Noise Figure at +85°C

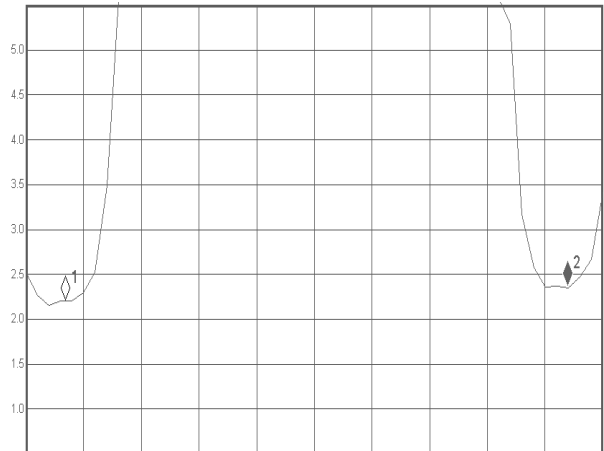

Return Loss

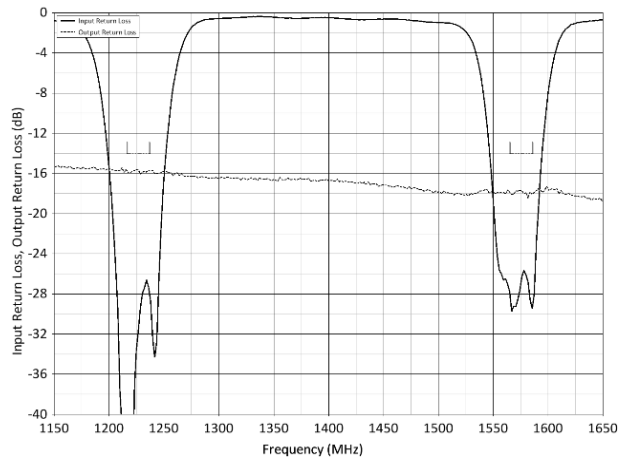

Group Delay

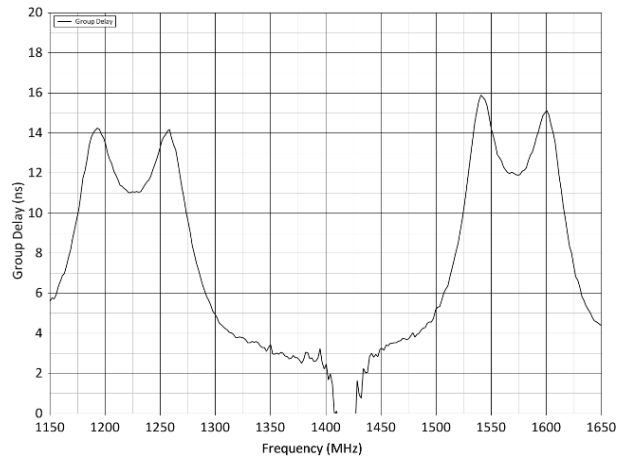

Environmental Conditions

Acceleration	MIL-STD-810D	Method 513.3 Helicopter Category
Altitude	MIL-STD-810F	Method 500.4 Class II
Shock	MIL-STD-810F MIL-STD-810D	Method 516.5 Procedures I, V, VI Method 416.5 Procedure V
Vibration	MIL-STD-810F	Method 514.6 Procedure I, Categories 13 (Propeller) & 14 (Helicopter)
Explosive Atmosphere	MIL-STD-810F	Method 511.4 Procedure I
Humidity	MIL-STD-810F	Method 507.4 Figure 507.4-1
Salt Fog	MIL-STD-810D	Method 509.2
Sand and Dust	MIL-STD-810F	Method 510.4 Procedures I, II
Electrical Bonding	MIL-STD-464	Section 5.10
Electrostatic Discharge ESD ¹	DO-160D	Section 25
Indirect Lightning Strike ¹	DO-160D	Section 22, Waveforms K & WF3
EMI	MIL-STD-461E	CE101, CE102, CE106, CS101, CS103, CS104, CS105, CS114, CS115, CS116, RE101, RE102, RS101, RS103 ²

1. Conditions met only with coaxially biased option.

Functional Block Diagram

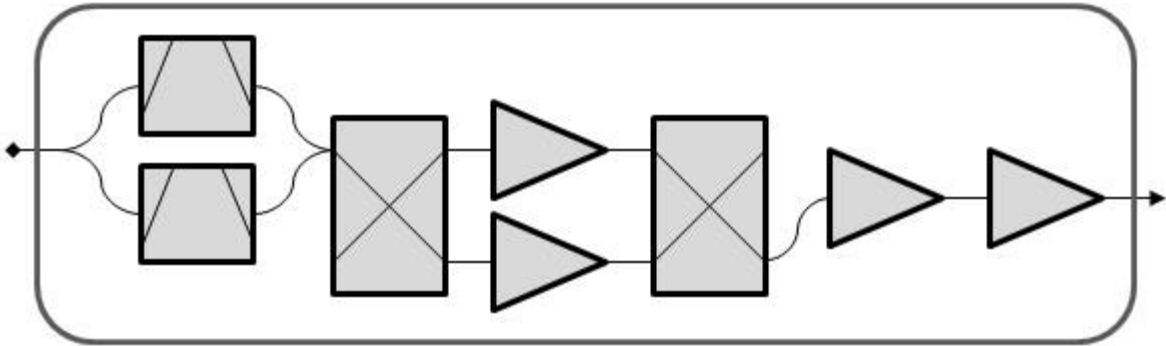

Absolute Maximum Ratings

Supply Voltage	+5-36 VDC +3.3 VDC	+40 VDC +6 VDC
RF Input Power, CW		+5 dBm
Storage Temperature		-40 to +125 °C
Operating Temperature		-40 to +85 °C
ESD Sensitivity		Class 1B



ELECTROSTATIC SENSITIVE DEVICE. OBSERVE PROPER HANDLING PRECAUTIONS

Ordering Information

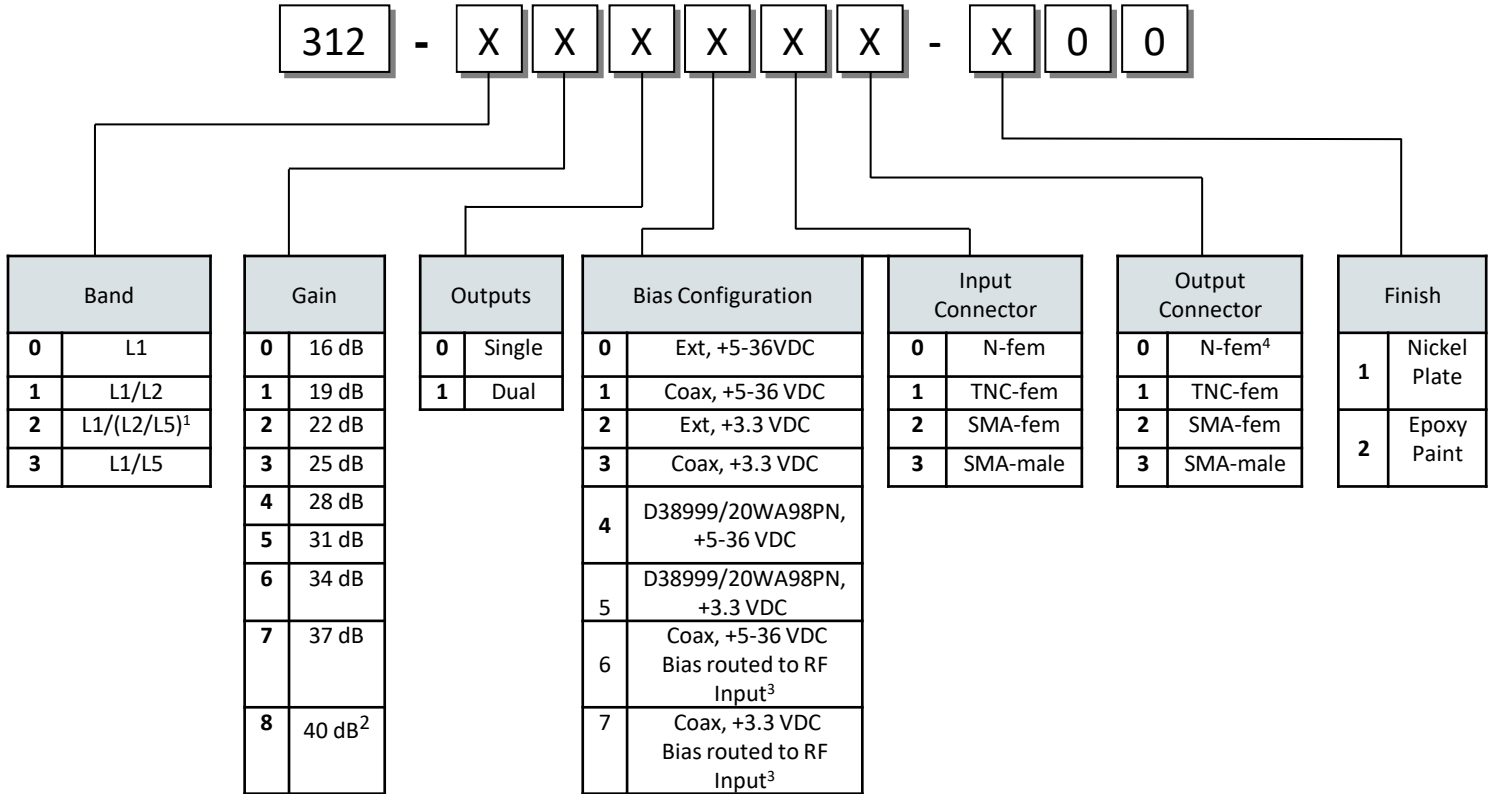

¹ The (L2/L5) bands are covered by a single bandpass pre-select filter

² 312-X81XXX-X00 40 dB gain, dual output model is not available

³ This bias option presents the supplied DC input voltage to the center pin of the RF input connector. This option is useful in applications where the user desires to source current to devices before the GPS LNA. The maximum current that can be sourced to the center pin using this option is 150 mA

⁴ Dual output configuration is not available with Type-N RF connectors in standard package

Outline Information

Outline	Bias Configuration	Input / Output Connectors	Notes
Outline 1	0,1,2,3	2	All bias configurations except 4 with SMA Female RF connector types
Outline 2	0,1,2,3	0,1,3	All bias configurations except 4 with TNC Type N, or SMA Male RF connector types
Outline 3	4	All	Bias configuration 4 with all RF connector types

Specifications are subject to change without notice

312 Series GPS LNAs

Outline Drawing 1

Weight: 47 grams typical

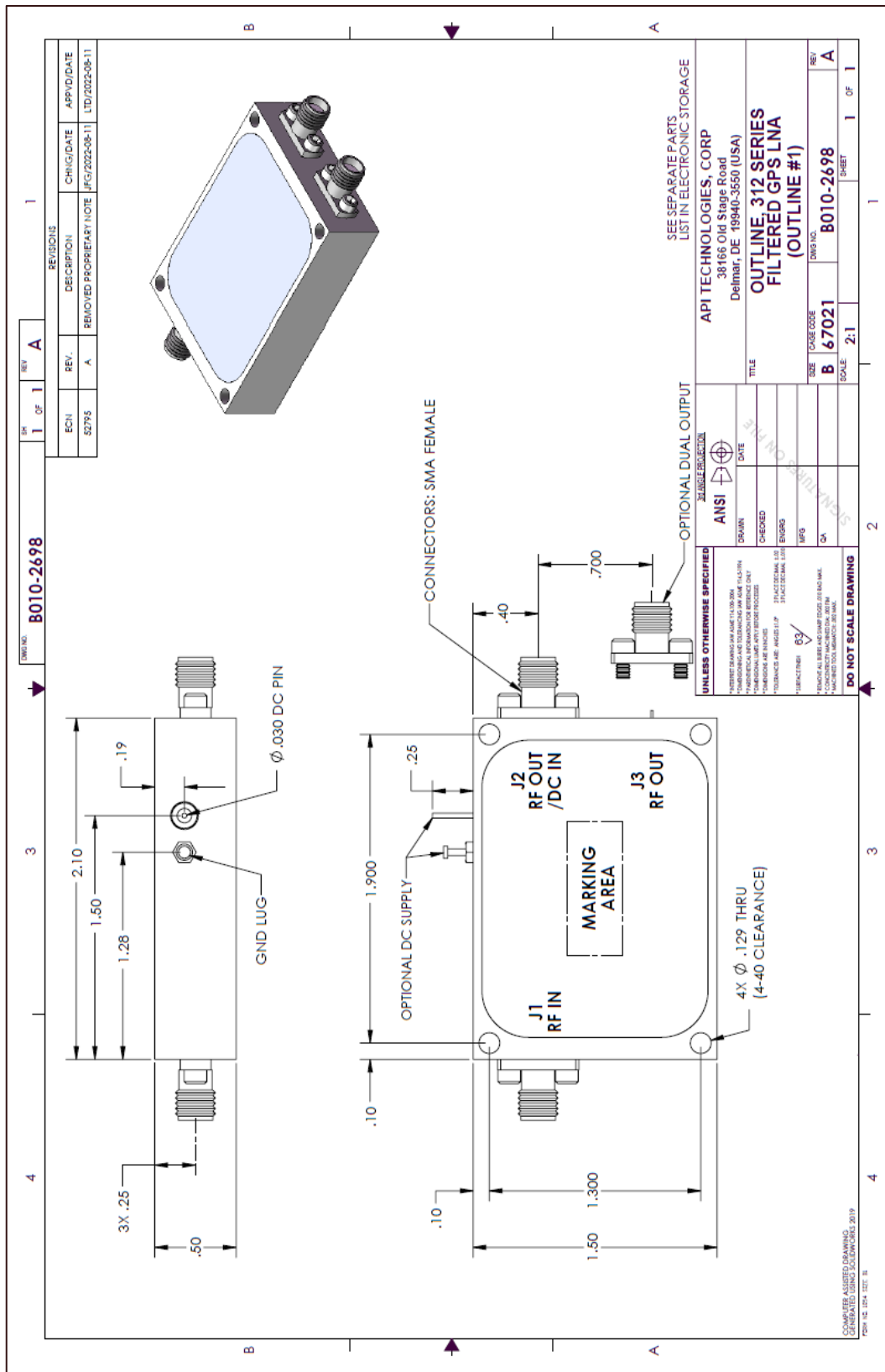

312 Series GPS LNAs

Outline Drawing 2

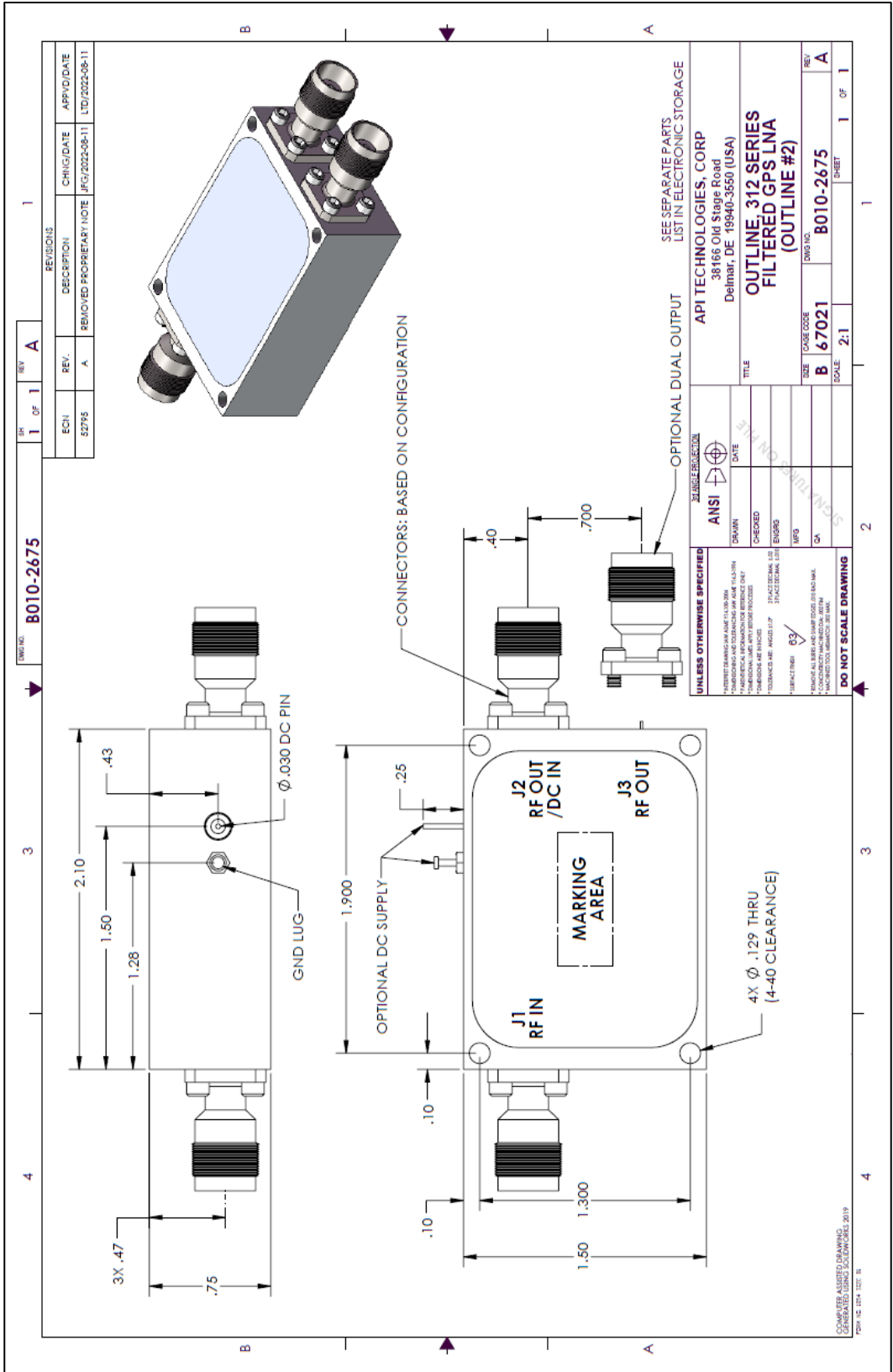

Outline Drawing 3

